

OUTDOOR LIGHTING

THE SPECSBOOK OF IN-LITE

www.in-lite.com

 @inlite_global

 @In-lite Global

 @inlite_global

in-lite[®]
OUTDOOR LIGHTING

in-lite[®]



DB-LED (WW)

Article number _____ 10102402
 VA _____ 0.50
 Output _____ 0.50 Watt
 CRI _____ 94
 Color temperature _____ 2850 K
 IP : 67

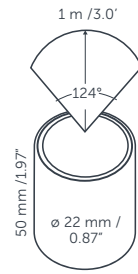
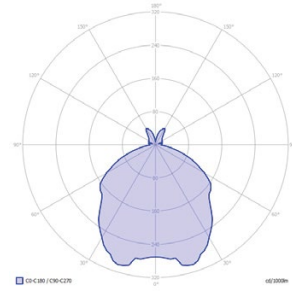

FUSION 22

Article number _____ 10104100
 VA _____ 0.20
 Output _____ 0.20 Watt
 CRI _____ 93
 Color temperature _____ 2750 K
 IP : 67

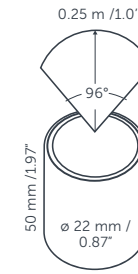
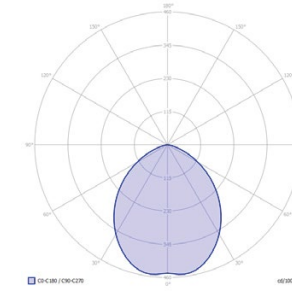

DB-LED (CW)

Article number _____ 10102503
 VA _____ 0.50
 Output _____ 0.50 Watt
 CRI _____ 79
 Color temperature _____ 5800 K
 IP : 67

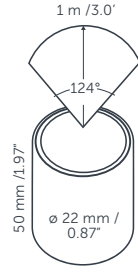
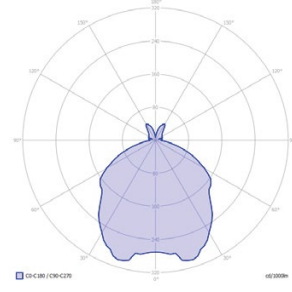

FUSION 22 RVS / BLACK

VA _____ 0.20
 Output _____ 0.20 Watt
 CRI _____ 93
 Color temperature _____ 2750 K
 IP : 67

■ Black ■ Stainless Steel
 10104190 10104150

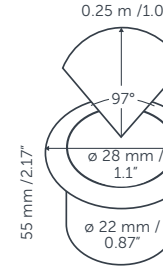
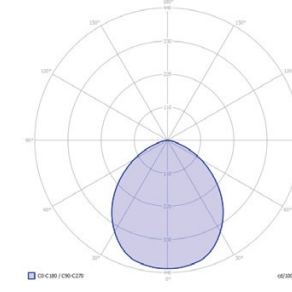

PUCK

VA _____ 2.50
 Output _____ 1.50 Watt
 CRI _____ 96
 Color temperature _____ 2900 K
 IP : 67

■ Black ■ Pearl Grey
 10104165 10104160

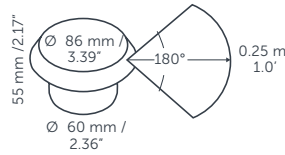
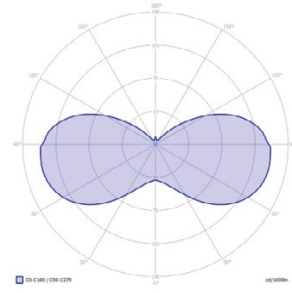

HYVE (COOL)

Article number _____ 10103900
 (Cool) 10103950
 VA _____ 0.80
 Output _____ 0.80 Watt
 CRI _____ 74
 Color temperature _____ 3000 K
 (Cool) 5500 K
 IP : 67

■ Stainless Steel

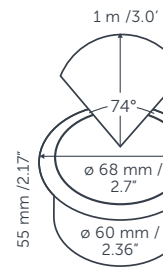
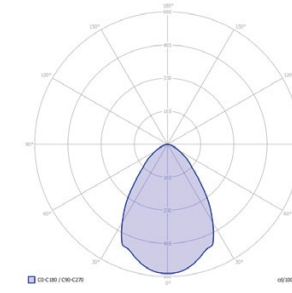

PUCK 22

VA _____ 0.60
 Output _____ 0.60 Watt
 CRI _____ 96
 Color temperature _____ 2900 K
 IP : 67

■ Black ■ Pearl Grey
 10104175 10104170

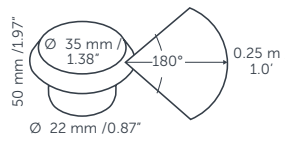
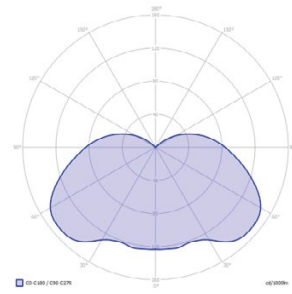

HYVE 22 RVS / BLACK

VA _____ 0.20
 Output _____ 0.20 Watt
 CRI _____ 95
 Color temperature _____ 3000 K
 IP : 67

■ Black ■ Stainless Steel
 10104090 10104000

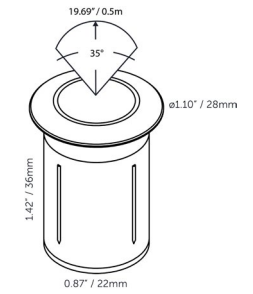
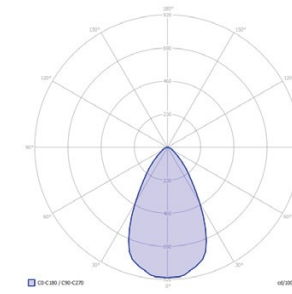

FUSION

Article number _____ 10101702
 VA _____ 1.00
 Output _____ 0.90 Watt
 CRI _____ 93
 Color temperature _____ 2650 K
 IP : 67

■ Stainless Steel

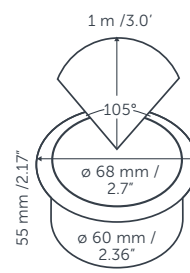
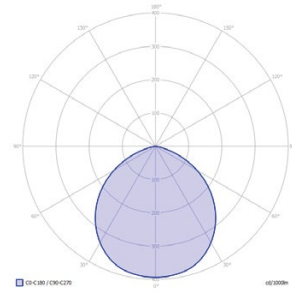

HYVE 22 RVS COOL

Article number _____ 10104020
 VA _____ 0.20
 Output _____ 0.20 Watt
 CRI _____ 72
 Color temperature _____ 5500 K
 IP : 67

■ Stainless Steel

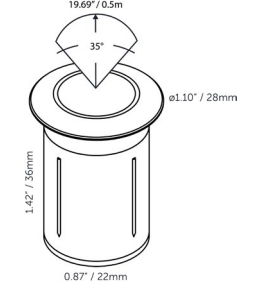
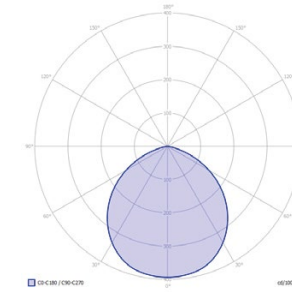



HYVE 22

Article number _____ 10104050
 VA _____ 0.20
 Output _____ 0.20 Watt
 CRI _____ 95
 Color temperature _____ 3100 K
 IP : 67

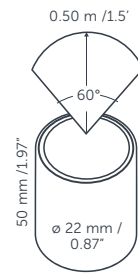
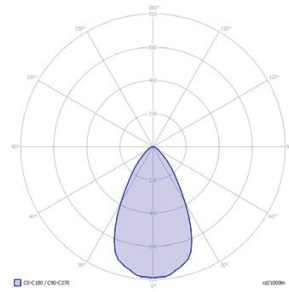

BIG FLUX ASYMMETRIC

Article number _____ 10103240
 VA _____ 4.20
 Output _____ 3.00 Watt
 CRI _____ 93
 Color temperature _____ 3100 K
 IP : 68

■ Black 10702380 ■ Pearl Grey 10702382
 ■ Stainless Steel 10702381

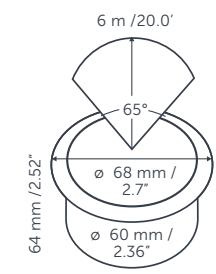
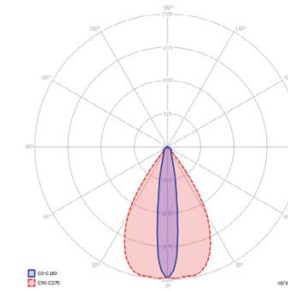

HYVE 22 COOL

Article number _____ 10104070
 VA _____ 0.20
 Output _____ 0.20 Watt
 CRI _____ 73
 Color temperature _____ 5800 K
 IP : 67

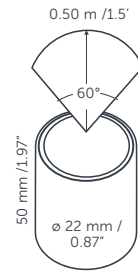
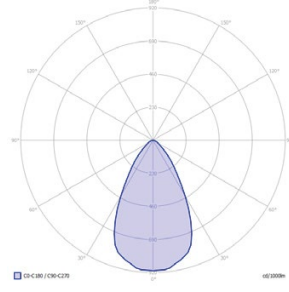

SMART FLUX TONE

Article number _____ 10103205
 VA _____ 9.5
 Output _____ 6.00 Watt
 Color temperature _____ 3100 K
 IP : 68

■ Black 10702380 ■ Pearl Grey 10702382
 ■ Stainless Steel 10702381

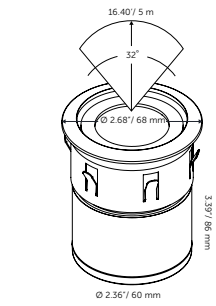
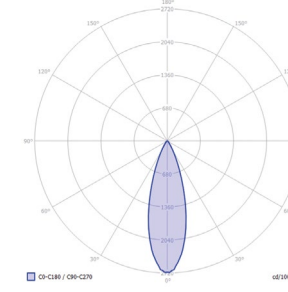

FLUX

Article number _____ 10103201
 VA _____ 2.50
 Output _____ 1.50 Watt
 CRI _____ 92
 Color temperature _____ 3000 K
 IP : 67

■ Stainless Steel

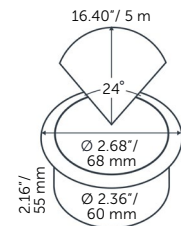
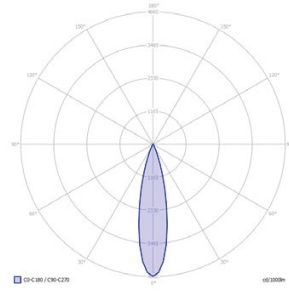

NERO

Article number _____ 10103401
 VA _____ 4.70
 Output _____ 3.00 Watt
 CRI _____ 91
 Color temperature _____ 3100 K
 IP : 67

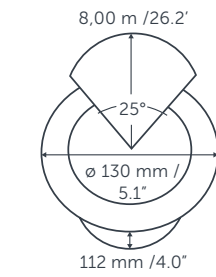
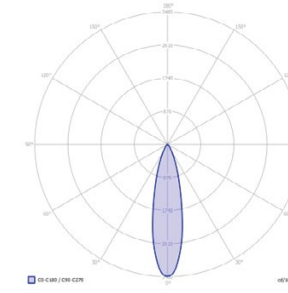

BIG FLUX

Article number _____ 10103210
 VA _____ 4.20
 Output _____ 3.00 Watt
 CRI _____ 93
 Color temperature _____ 3100 K
 IP : 68

■ Black 10702380 ■ Pearl Grey 10702382
 ■ Stainless Steel 10702381

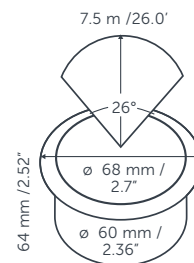
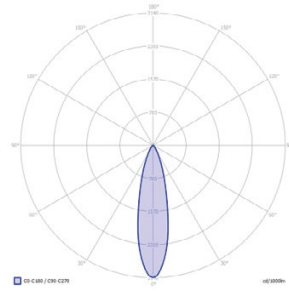

BIG NERO

Article number _____ 10103451
 VA _____ 11.90
 Output _____ 7.50 Watt
 CRI _____ 90
 Color temperature _____ 3100 K
 IP : 67

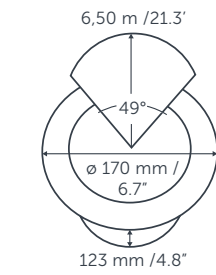
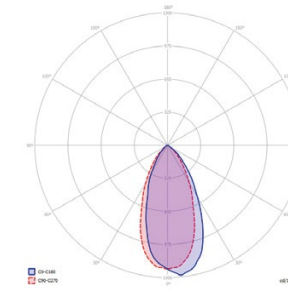

BIG FLUX NARROW

Article number _____ 10103220
 VA _____ 4.20
 Output _____ 3.00 Watt
 CRI _____ 93
 Color temperature _____ 3100 K
 IP : 67

■ Black 10702380 ■ Pearl Grey 10702382
 ■ Stainless Steel 10702381

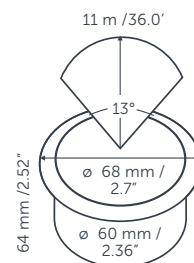
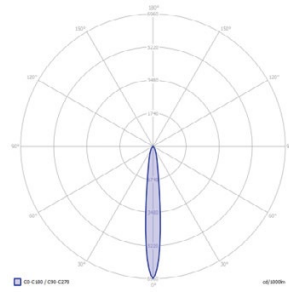

BIG NERO NARROW

Article number _____ 10103460
 VA _____ 11.90
 Output _____ 7.50 Watt
 CRI _____ 91
 Color temperature _____ 3100 K
 IP : 67

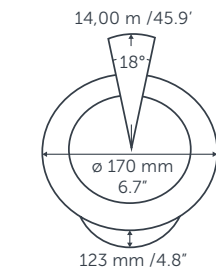
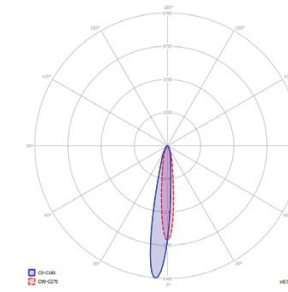

EVO GROUND 300

Article number 10104500
 VA 1.0
 Output 1.0 Watt
 CRI 95
 Color temperature 3000 K
 IP: 67

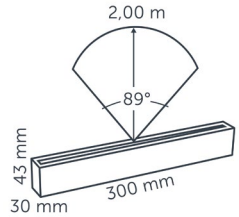
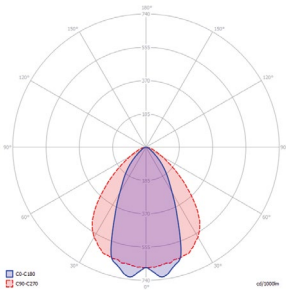

EVO FLOOD

Article number 10401300
 VA 8.0
 Output 5.00 Watt
 CRI 97
 Color temperature 3000 K
 IP: 55

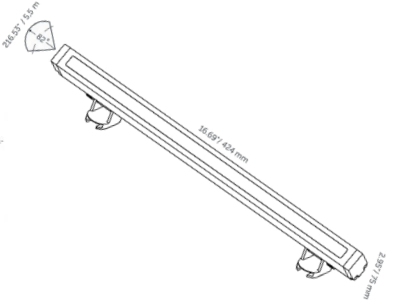
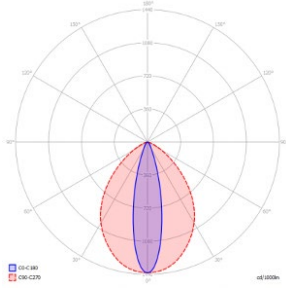

LUNA

Article number 10104180
 VA 5.00
 Output 3,00 Watt
 CRI 94
 Color temperature 3100 K
 IP: 68



- Black 10702380
- Pearl Grey 10702382
- Stainless Steel 10702381

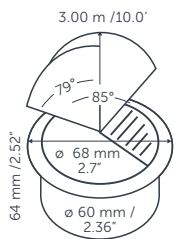
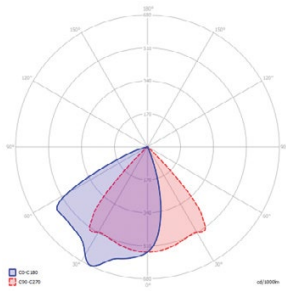

Accessories recessed lights: SPIKE / BOX / PLATE / RING





MICRO SCOPE

Article number 10400625
 VA 1.10
 Output 0.60 Watt
 CRI 91
 Color temperature 2900 K
 IP: 67

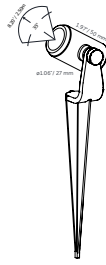
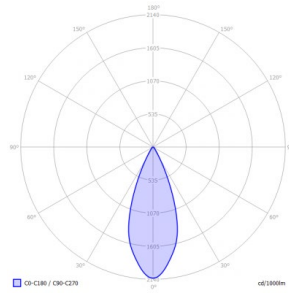

BIG SCOPE

Article number 10401002
 VA 8.00
 Output 5.00 Watt
 CRI 91
 Color temperature 3100 K
 IP: 67

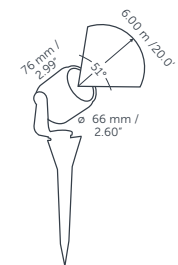
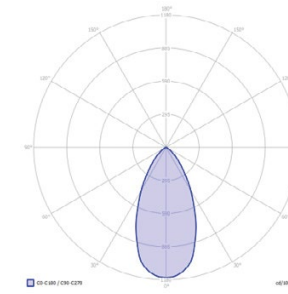

MINI SCOPE

Article number 10400601
 VA 2.00
 Output 1.00 Watt
 CRI 93
 Color temperature 2900 K
 IP: 67

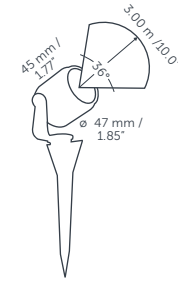
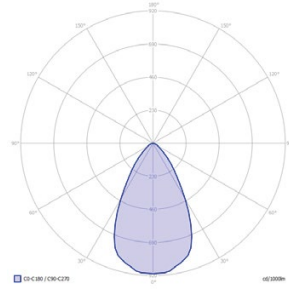

BIG SCOPE NARROW

Article number 10400902
 VA 8.00
 Output 5.00 Watt
 CRI 92
 Color temperature 3100 K
 IP: 67

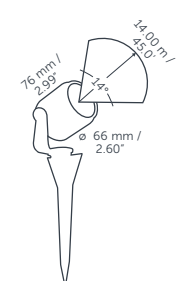
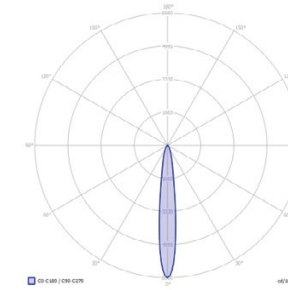

MINI SCOPE DUO

Article number 10400606
 VA 4.00
 Output 2.00 Watt
 CRI 93
 Color temperature 2900 K
 IP: 67

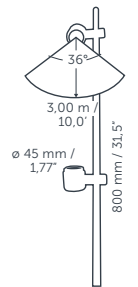
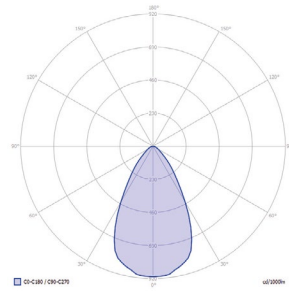

SUB

Article number 10401101
 VA 4.70
 Output 3.00 Watt
 CRI 93
 Color temperature 3000 K
 IP: 68

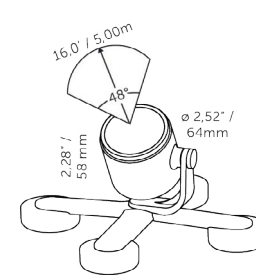
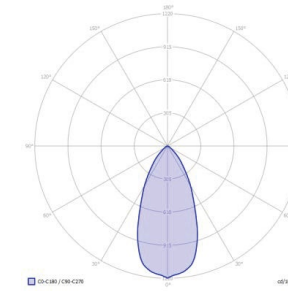

SCOPE

Article number 10400503
 VA 5.20
 Output 3.00 Watt
 CRI 91
 Color temperature 3100 K
 IP: 67

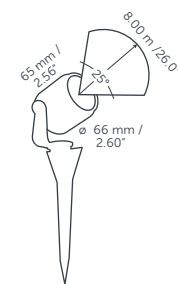
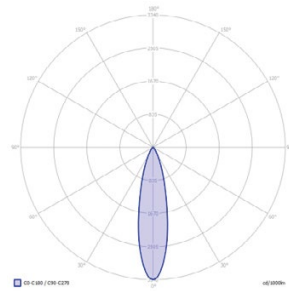

AIM

Article number 10401360
 VA 2.10
 Output 1.20 Watt
 CRI 95
 Color temperature 3000 K
 IP: 67

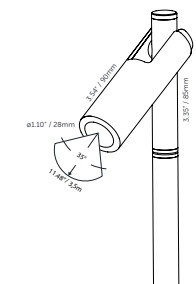
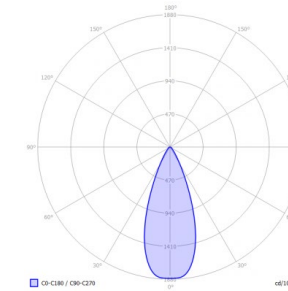

SMART SCOPE TONE

Article number 10401050
 VA 9.50
 Output 6.00 Watt
 Color temperature 3100 K
 IP: 67

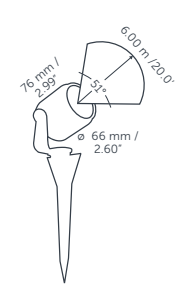
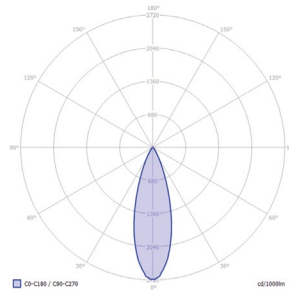

Accessories for spots: SHIELD / KILLFLASH / RISER / BRACE

MINI SCOPE

ILLUMINANCE - CONE OF LIGHT		
CENTER BEAM (FC)	BEAM DIAMETER (FT)	DISTANCE (FT)
5	3.25	5.0
3	4.22	6.5
2	5.20	8.0
1	6.17	9.5
1	7.15	11.0
1	8.12	12.5

Beam angle (0-180°) (90-270°): 36°
edge illuminance is 1/2 of Centre beam

SMART SCOPE TONE

ILLUMINANCE - CONE OF LIGHT		
CENTER BEAM (FC)	BEAM DIAMETER (FT)	DISTANCE (FT)
43	1.72	3.0
11	3.44	6.0
5	5.16	9.0
3	6.88	12.0
2	8.60	15.0
1	10.32	18.0

Beam angle (0-180°) (90-270°): 32°
edge illuminance is 1/2 of Centre beam

MINI SCOPE DUO

ILLUMINANCE - CONE OF LIGHT		
CENTER BEAM (FC)	BEAM DIAMETER (FT)	DISTANCE (FT)
5	3.25	5.0
3	4.22	6.5
2	5.20	8.0
1	6.17	9.5
1	7.15	11.0
1	8.12	12.5

Beam angle (0-180°) (90-270°): 36°
edge illuminance is 1/2 of Centre beam

BIG SCOPE

ILLUMINANCE - CONE OF LIGHT		
CENTER BEAM (FC)	BEAM DIAMETER (FT)	DISTANCE (FT)
20	4.77	5.0
5	9.54	10.0
2	14.31	15.0
1	19.08	20.0
1	23.85	25.0
1	28.62	30.0

Beam angle (0-180°) (90-270°): 51°
edge illuminance is 1/2 of Centre beam

SCOPE

ILLUMINANCE - CONE OF LIGHT		
CENTER BEAM (FC)	BEAM DIAMETER (FT)	DISTANCE (FT)
21	2.88	6.5
5	5.76	13.0
10	4.21	19.5
1	11.53	26.0
1	14.41	32.5
1	17.51	39.5

Beam angle (0-180°) (90-270°): 25°
edge illuminance is 1/2 of Centre beam

BIG SCOPE NARROW

ILLUMINANCE - CONE OF LIGHT		
CENTER BEAM (FC)	BEAM DIAMETER (FT)	DISTANCE (FT)
4	8.24	26.0
3	10.14	32.0
2	12.04	38.0
2	13.94	44.0
1	15.84	50.0
1	17.74	56.0

Beam angle (0-180°) (90-270°): 18°
edge illuminance is 1/2 of Centre beam

MICRO SCOPE

ILLUMINANCE - CONE OF LIGHT		
CENTER BEAM (FC)	BEAM DIAMETER (FT)	DISTANCE (FT)
24	1.26	2.0
6	2.52	4.0
3	3.78	6.0
1	5.04	8.0
1	5.31	10.0
1	7.57	12.0

Beam angle (0-180°) (90-270°): 35°
edge illuminance is 1/2 of Centre beam

SUB

ILLUMINANCE - CONE OF LIGHT		
CENTER BEAM (FC)	BEAM DIAMETER (FT)	DISTANCE (FT)
14	4.45	5.0
4	8.90	10.0
2	13.36	15.0
1	17.81	20.0
1	22.26	25.0
0	26.71	30.0

Beam angle (0-180°) (90-270°): 48°
edge illuminance is 1/2 of Centre beam

AIM

ILLUMINANCE - CONE OF LIGHT		
CENTER BEAM (FC)	BEAM DIAMETER (FT)	DISTANCE (FT)
39	1.26	2.0
10	2.52	4.0
4	3.78	6.0
2	5.04	8.0
2	6.31	10.0
1	7.57	12.0

Beam angle (0-180°) (90-270°): 35°
edge illuminance is 1/2 of Centre beam



SPOTS

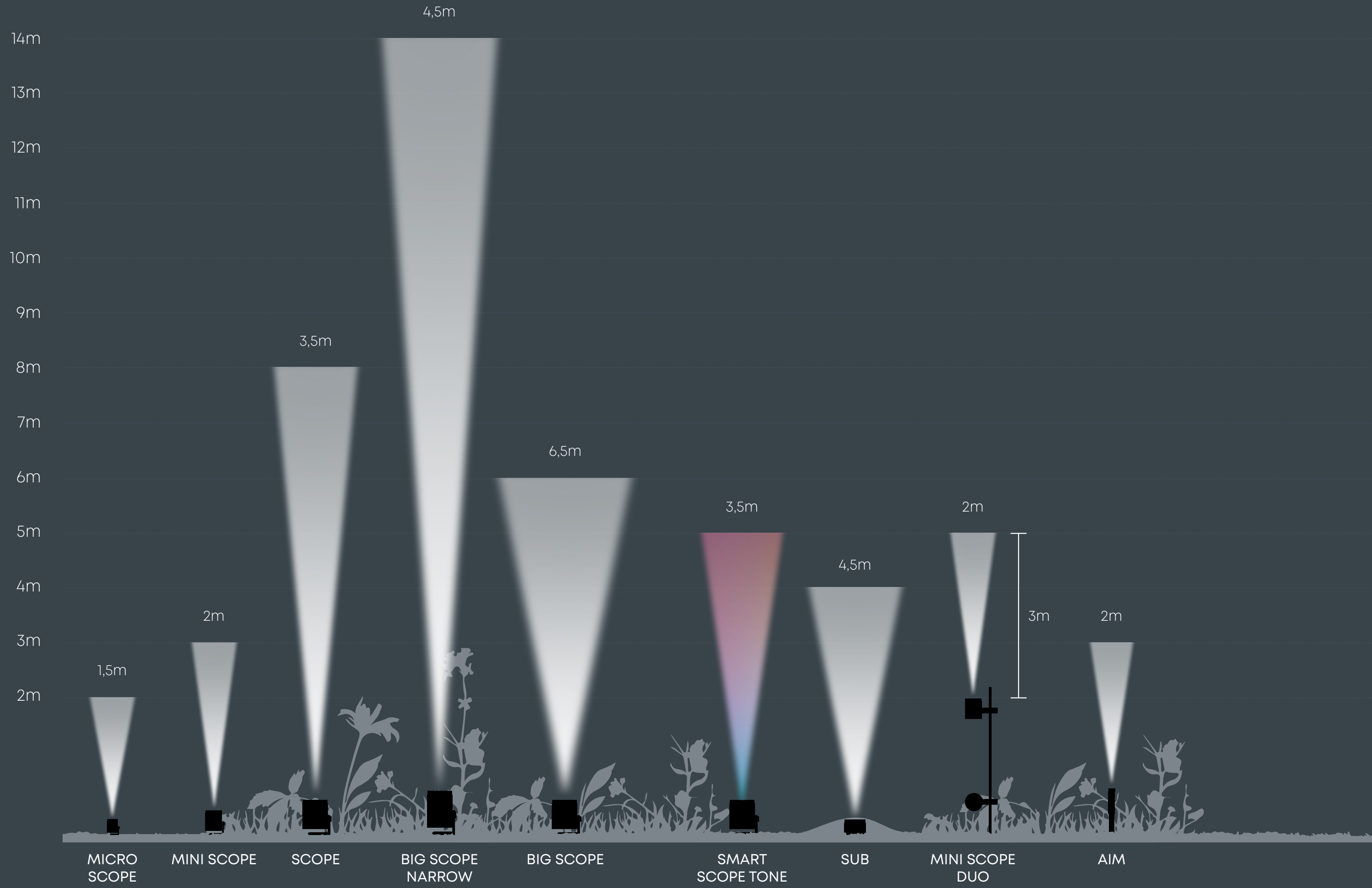

LIV LOW

VA _____ 2.50
 Output _____ 1.50 Watt
 CRI _____ 95
 Color temperature _____ 2750 K
 IP: 55

- Corten 10201782
- Dark Grey 10201761
- White 10201776
- Rose Silver 10201751

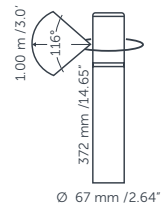
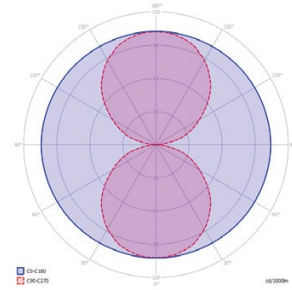

EVO

Article number _____ 10202500
 VA _____ 2.10
 Output _____ 2.00 Watt
 CRI _____ 95
 Color temperature _____ 2950 K
 IP: 55

- Black

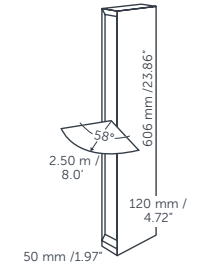
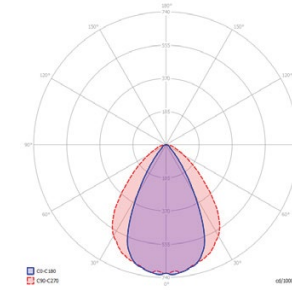

LIV

VA _____ 2.50
 Output _____ 1.50 Watt
 CRI _____ 95
 Color temperature _____ 2750 K
 IP: 55

- Corten 10201732
- Dark Grey 10201716
- White 10201726
- Rose Silver 10201701

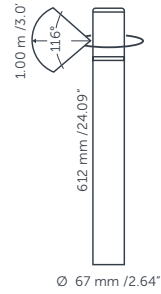
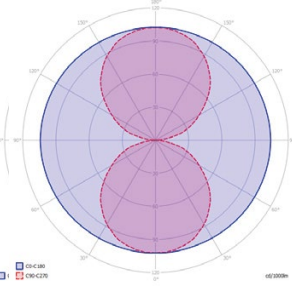

DISC LOW

Article number _____ 10202600 (HEAD)
 _____ 10202640 (TUBE LOW)
 VA _____ 4.90
 Output _____ 3.00 Watt
 CRI _____ 98
 Color temperature _____ 2900 K
 IP: 55

- Black

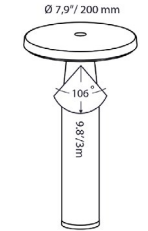
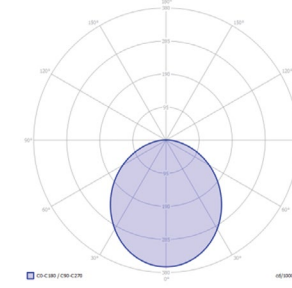

ACE

VA _____ 5.30
 Output _____ 3.00 Watt
 CRI _____ 94
 Color temperature _____ 3000 K
 IP: 55

- Corten 10202361
- Dark Grey 10202350
- White 10202355
- Rose Silver 10202300

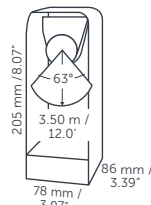
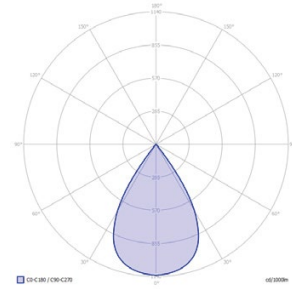

DISC

Article number _____ 10202600 (HEAD)
 _____ - (TUBE)
 VA _____ 4.90
 Output _____ 3.00 Watt
 CRI _____ 98
 Color temperature _____ 2900 K
 IP: 55

- Black

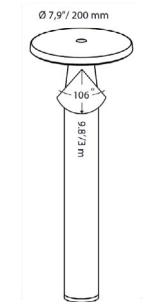
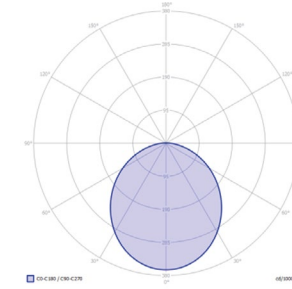

ACE HIGH

VA _____ 5.30
 Output _____ 3.00 Watt
 CRI _____ 94
 Color temperature _____ 3000 K
 IP: 55

- Corten 10201803
- Dark Grey 10201790
- White 10201795
- Rose Silver 10201785

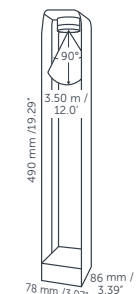
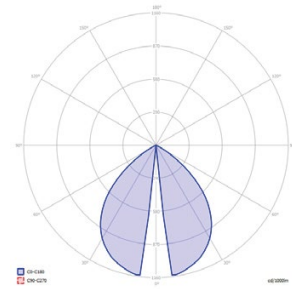

SWAY

VA _____ 1.0
 Output _____ 1.0 Watt
 CRI _____ 95
 Color temperature _____ 2900 K
 IP: 55

- Pearl Grey 10202405
- Black 10202400

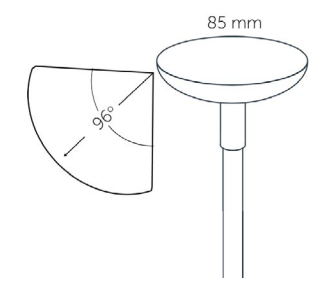
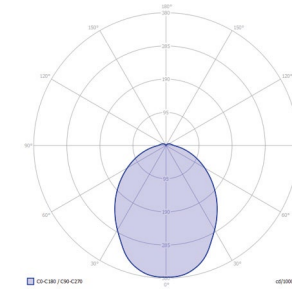

EVO LOW

Article number _____ 10202510
 VA _____ 2.10
 Output _____ 2.00 Watt
 CRI _____ 95
 Color temperature _____ 2950 K
 IP: 55

- Black

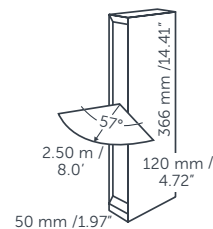
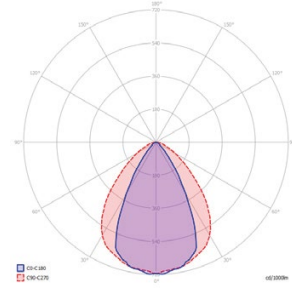

MINI SWAY

VA _____ 0.60
 Output _____ 0.50 Watt
 CRI _____ 95
 Color temperature _____ 2900 K
 IP: 55

- Pearl Grey 10202415
- Black 10202410

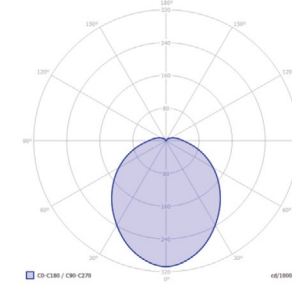



SWAY TABLE

Article number 10202460
 VA 1.80
 Output 1.80 Watt
 CRI 96
 Color temperature 2900 K
 IP: 55

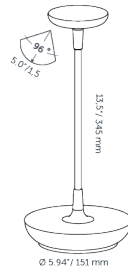
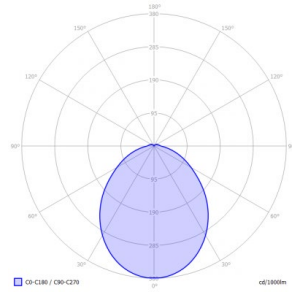

VOQUE

Article number 10202700
 VA 5.20
 Output 3.00 Watt
 CRI 89
 Color temperature 2750 K
 IP: 55

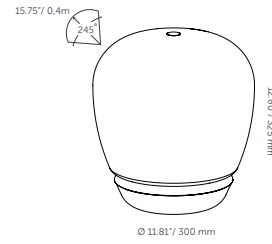
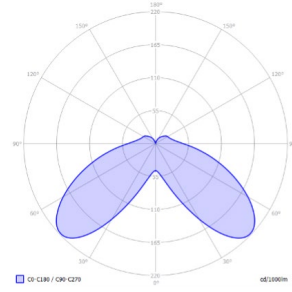

BIG VOQUE

Article number 10202705
 VA 8.00
 Output 5.00 Watt
 CRI 89
 Color temperature 2750 K
 IP: 55

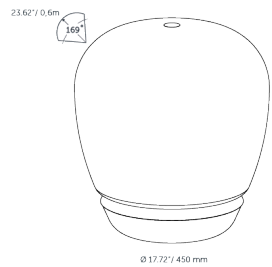
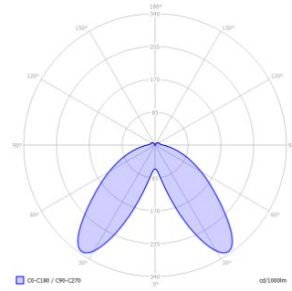

NAIL LOW

Article number 10202755
 VA 1.50
 Output 1.00 Watt
 CRI 96
 Color temperature 2900 K
 IP: 55

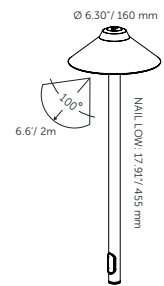
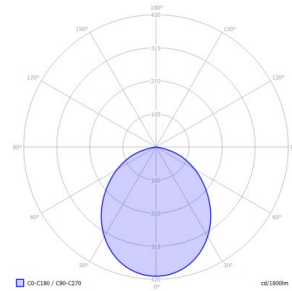

NAIL

Article number 10202750
 VA 1.50
 Output 1.00 Watt
 CRI 96
 Color temperature 2900 K
 IP: 55

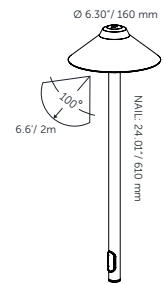
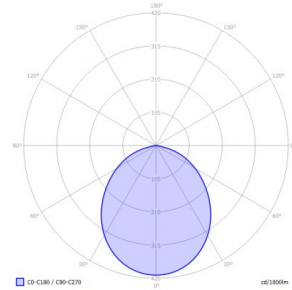

Accessories for ACE: WINK | Accessories for SWAY & MINI SWAY: (MINI) SWAY CAP | Accessories for VOQUE: BELT / TRIPOD



CUBID

VA _____ 0.60
 Output _____ 0.60 Watt
 CRI _____ 93
 Color temperature _____ 2800 K
 IP: 55

- Dark Grey 10301006
- White 10301011 ■ Rose Silver 10301001

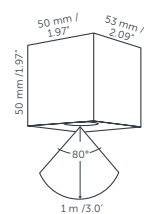
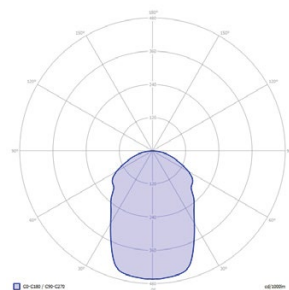

WEDGE SLIM

Article number _____ 10301770
 VA _____ 1.00
 Output _____ 1.00 Watt
 CRI _____ 96
 Color temperature _____ 2800 K
 IP: 55

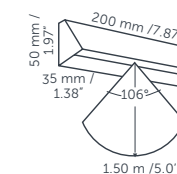
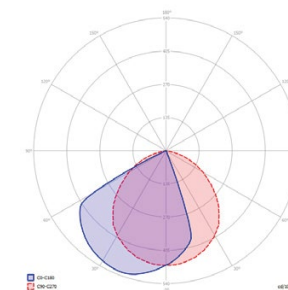

BIG CUBID

VA _____ 2.00
 Output _____ 1.00 Watt
 CRI _____ 93
 Color temperature _____ 2900 K
 IP: 55

- Dark Grey 10301015
- White 10301020 ■ Rose Silver 10301025

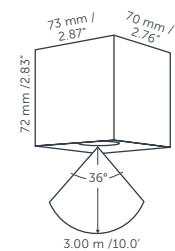
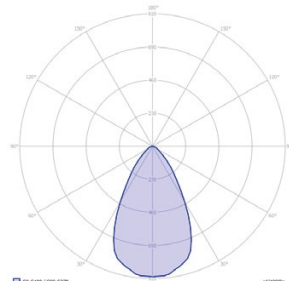

MINI WEDGE

Article number _____ 10301780
 VA _____ 0.60
 Output _____ 0.60 Watt
 CRI _____ 95
 Color temperature _____ 2900 K
 IP: 55

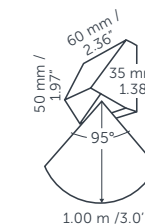
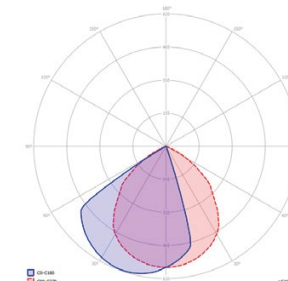

LIV WALL

VA _____ 2.50
 Output _____ 1.50 Watt
 CRI _____ 95
 Color temperature _____ 2750 K
 IP: 55

- Dark Grey 10301105
- White 10301110 ■ Rose Silver 10301100

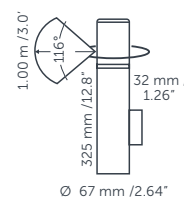
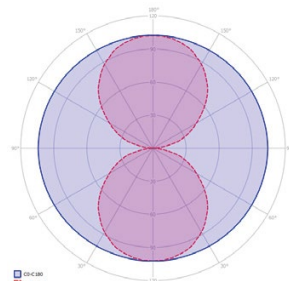

ACE DOWN

VA _____ 5.30
 Output _____ 3.00 Watt
 CRI _____ 91
 Color temperature _____ 3000 K
 IP: 55

- Corten 10301861 ■ Dark Grey 10301850
- White 10301855 ■ Rose Silver 10301800

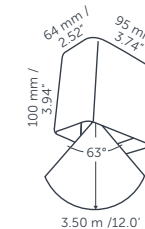
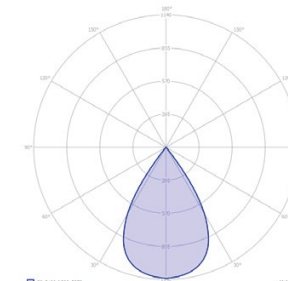

BLINK

VA _____ 1.70
 Output _____ 1.00 Watt
 CRI _____ 95
 Color temperature _____ 2800 K
 IP: 55

- Dark Grey 10301250
- White 10301265 ■ Rose Silver 10301200

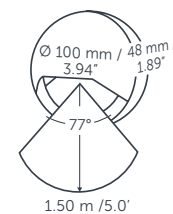
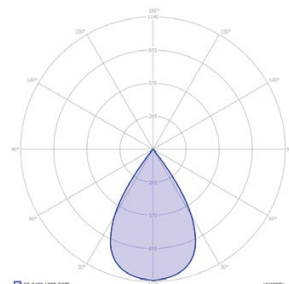

ACE UP-DOWN

VA _____ 10.30
 Output _____ 6.50 Watt
 CRI _____ 92
 Color temperature _____ 3000 K
 IP: 55

- Corten 10301961 ■ Dark Grey 10301950
- White 10301955 ■ Rose Silver 10301900

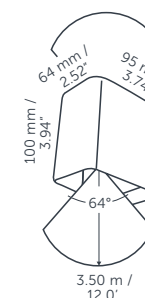
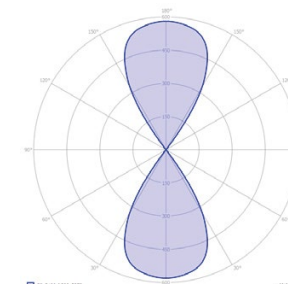

WEDGE

VA _____ 1.60
 Output _____ 1.00 Watt
 CRI _____ 94
 Color temperature _____ 2800 K
 IP: 55

- Dark Grey 10301750
- White 10301765 ■ Rose Silver 10301700

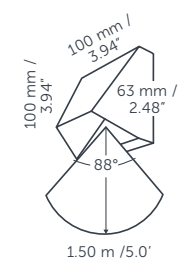
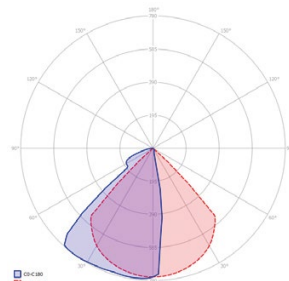

ACE DOWN 100-230V

VA _____ 11.80
 Output _____ 4.50 Watt
 CRI _____ 95
 Color temperature _____ 3000 K
 IP: 55

- Corten 10302121 ■ Dark Grey 10302110
- White 10302115 ■ Rose Silver 10302105

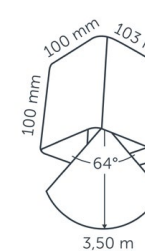
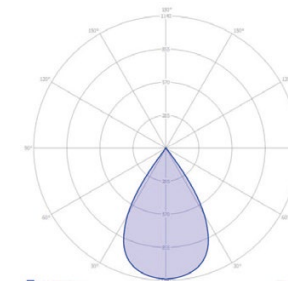

ACE UP-DOWN 100-230V

VA _____ 20.00
 Output _____ 8.50 Watt
 CRI _____ 92
 Color temperature _____ 3000 K
 IP : 55

- Corten 10302061 ■ Dark Grey 10302050
- White 10302055 ■ Rose Silver 10302000

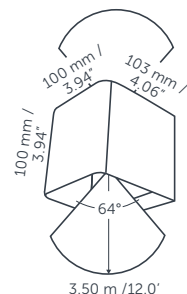
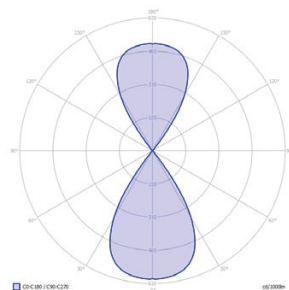

HALO UP-DOWN

Article number _____ 10302605
 VA _____ 10.00
 Output _____ 6.50 Watt
 CRI _____ 92
 Color temperature _____ 3000 K
 IP : 55

- Black

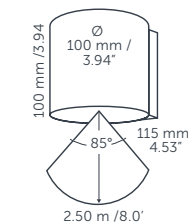
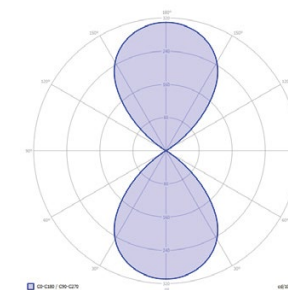

EVO DOWN

Article number _____ 10302500
 VA _____ 2.10
 Output _____ 2.00 Watt
 CRI _____ 95
 Color temperature _____ 2950 K
 IP : 53

- Black

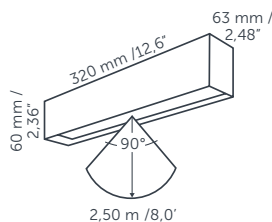
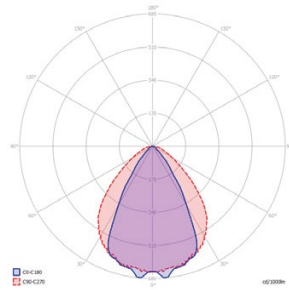

HALO UP-DOWN 100-230V

Article number _____ 10302610
 VA _____ 20.00
 Output _____ 8.50 Watt
 CRI _____ 93
 Color temperature _____ 3000 K
 IP : 55

- Black

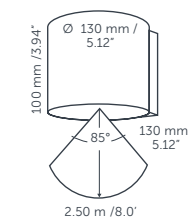
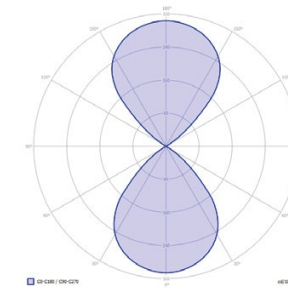

EVO DOWN 100-230V

Article number _____ 10302505
 VA _____ 11.50
 Output _____ 4.50 Watt
 CRI _____ 92
 Color temperature _____ 3000 K
 IP : 55

- Black

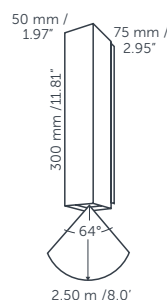
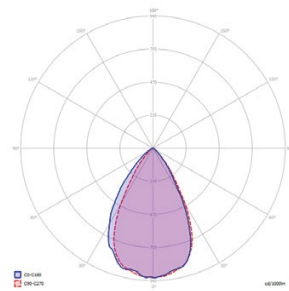

DISC WALL

Article number _____ 10202600
 VA _____ 4.90
 Output _____ 3.00 Watt
 CRI _____ 98
 Color temperature _____ 2900 K
 IP : 55

- Black

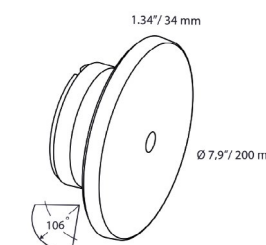
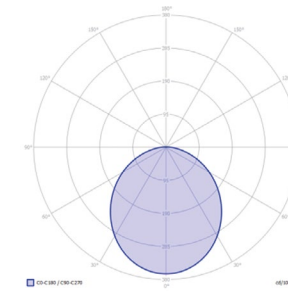

HALO DOWN

Article number _____ 10302600
 VA _____ 5.00
 Output _____ 3.00 Watt
 CRI _____ 92
 Color temperature _____ 3000 K
 IP : 55

- Black

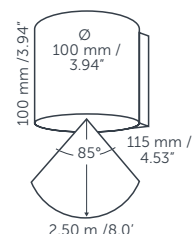
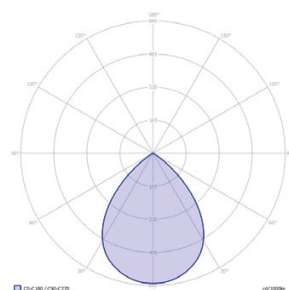

DISC WALL 100-230V

Article number _____ 10302710
 VA _____ 4.70
 Output _____ 4.50 Watt
 CRI _____ 98
 Color temperature _____ 2900 K
 IP : 55

- Black

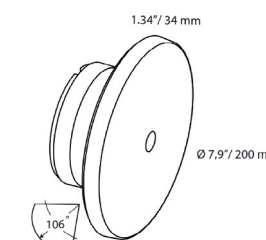
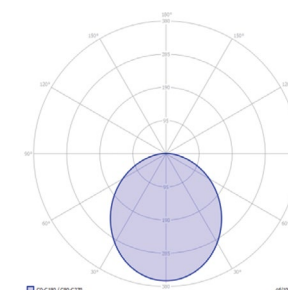

HALO DOWN 100-230V

Article number _____ 10302615
 VA _____ 11.50
 Output _____ 4.50 Watt
 CRI _____ 92
 Color temperature _____ 3000 K
 IP : 55

- Black

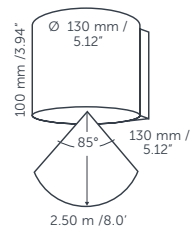
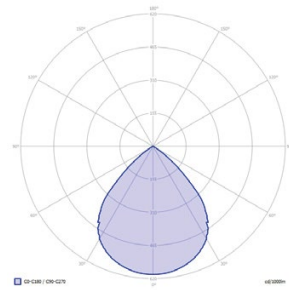

SWAY WALL

VA _____ 1.00
 Output _____ 1.00 Watt
 CRI _____ 95
 Color temperature _____ 2900 K
 IP : 55

- Black 10202400 ■ Dark Grey 10202405

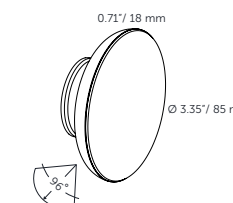
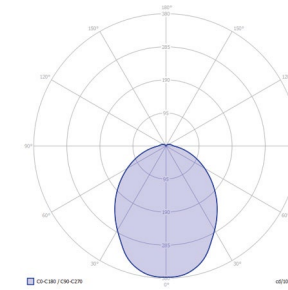

MINI SWAY WALL

VA _____ 0.50
 Output _____ 0.60 Watt
 CRI _____ 96
 Color temperature _____ 2900 K
 IP : 55

■ Black 10202410 ■ Dark Grey 10202415

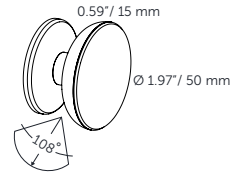
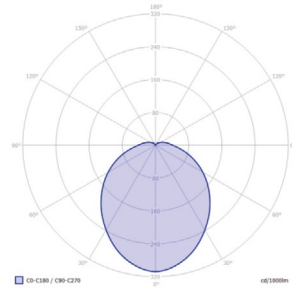

Accessories for wall lights: SHUTTER / FIT / WALL MOUNT

SCOPE CEILING

Article number _____ 10400510
 VA _____ 4.80
 Output _____ 3.00 Watt
 CRI _____ 91
 Color temperature _____ 3100 K
 IP : 67

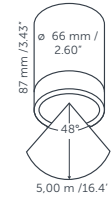
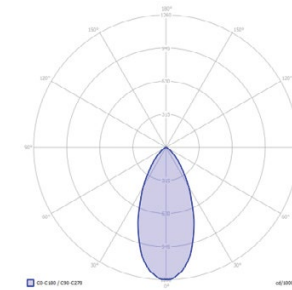

DISC PENDANT

Article number _____ 10202650
 VA _____ 4.90
 Output _____ 3.00 Watt
 CRI _____ 98
 Color temperature _____ 2900 K
 IP : 55



■ Black

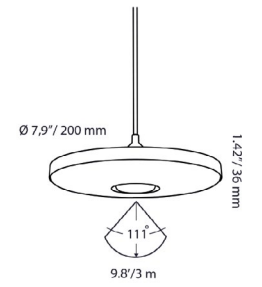
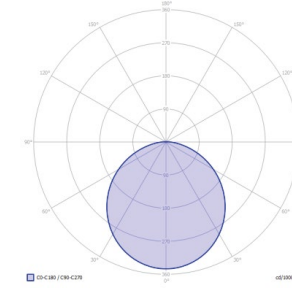

DISC PENDANT 100-230V

Article number _____ 10202670
 VA _____ 11.80
 Output _____ 4.50 Watt
 CRI _____ 98
 Color temperature _____ 2900 K
 IP : 55



■ Black

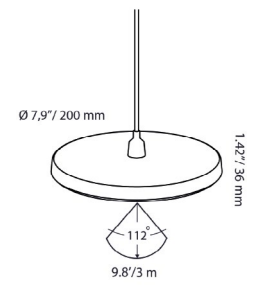
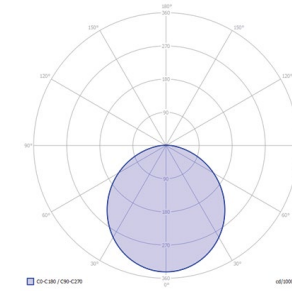

SWAY PENDANT

VA _____ 1.00
 Output _____ 0.90 Watt
 CRI _____ 96
 Color temperature _____ 2900 K
 IP : 55

■ Black 10202465 ■ Dark Grey 10202490

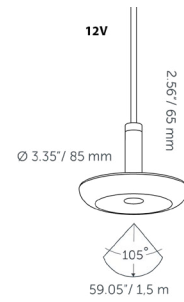
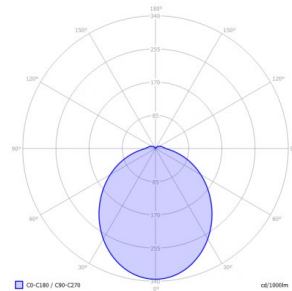

AIM CEILING

Article number _____ 10401365
 VA _____ 2.10
 Output _____ 1.20 Watt
 CRI _____ 90
 Color temperature _____ 3000 K
 IP : 67

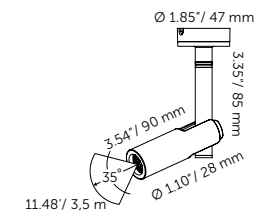
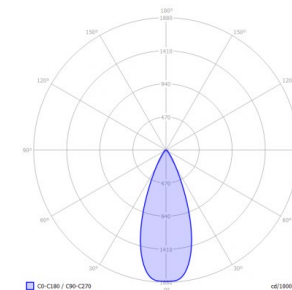

SWAY PENDANT 100-230V

VA _____ 7.10
 Output _____ 2.50 Watt
 CRI _____ 96
 Color temperature _____ 2900 K
 IP : 55

■ Black 10202470 ■ Dark Grey 10202495

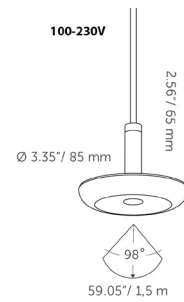
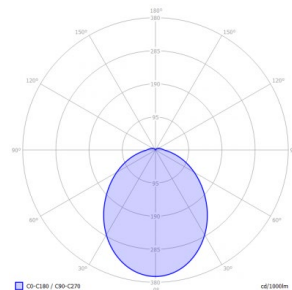

Accessories pendant lights: BASE 1 / BASE 2 / BASE TRIPLE / SPLITTER

MINI SCOPE CEILING

Article number _____ 10400610
 VA _____ 2.00
 Output _____ 1.00 Watt
 CRI _____ 93
 Color temperature _____ 2900 K
 IP : 55

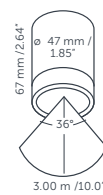
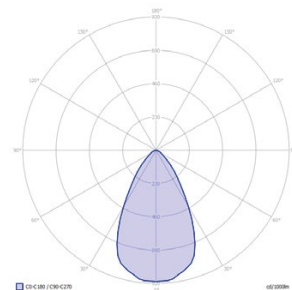

EVO HYDE 180C

Article number 10202600
 VA 0.60
 Output 0.50 Watt
 CRI 95
 Color temperature 2950 K
 IP : 53

■ Rose Silver 10250100 ■ Black 10250105

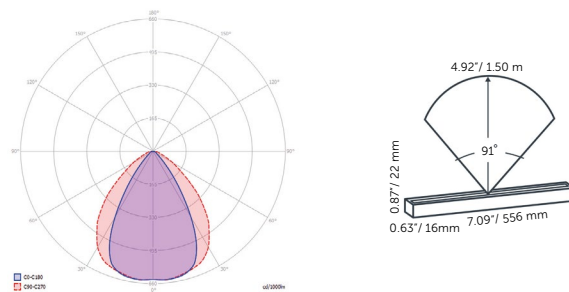

EVO HYDE 550

Article number 10250150
 VA 2.10
 Output 2.00 Watt
 CRI 93
 Color temperature 2950 K
 IP : 55

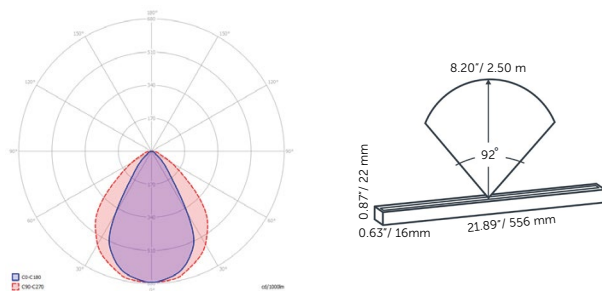

EVO FLEX 1, 2 & 3

VA 9,90 / 15,70 / 20,20
 Output 6,50 / 11,00 / 14,50 Watt
 CRI 86
 Color temperature 3000 K
 IP : 68

1. 10250300 2. 10250305 3. 10250310

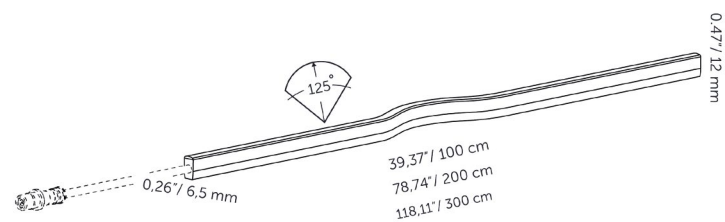

SMART EVO FLEX 1, 2 & 3

VA 9,90 / 15,70 / 20,20
 Output 6,50 / 11,00 / 14,50 Watt
 CRI 86
 Color temperature 3000 K
 IP : 68

1. 10250300 2. 10250305 3. 10250310

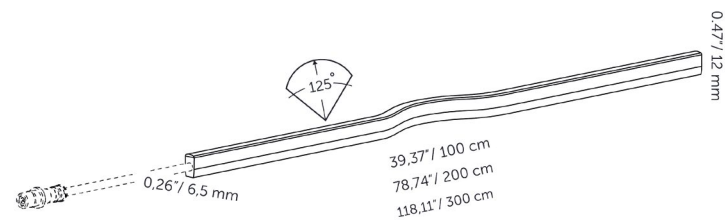

SMART EVO FLEX TONE 1, 2 & 5

VA 4,50 / 7,50 / 14,50
 Output 2,50 / 4,50 / 10,00 Watt
 CRI 95
 Color temperature 3100 K
 IP : 68

1. 10250400 2. 10250405 3. 10250420

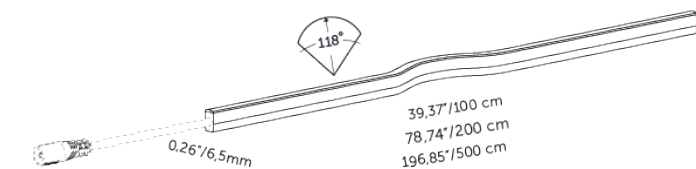

Accessories for EVO HYDE: FIX 3, 4 & 5 | Accessories for EVO FLEX: PROFILES / CORNERS / SPIKES / CLIPS

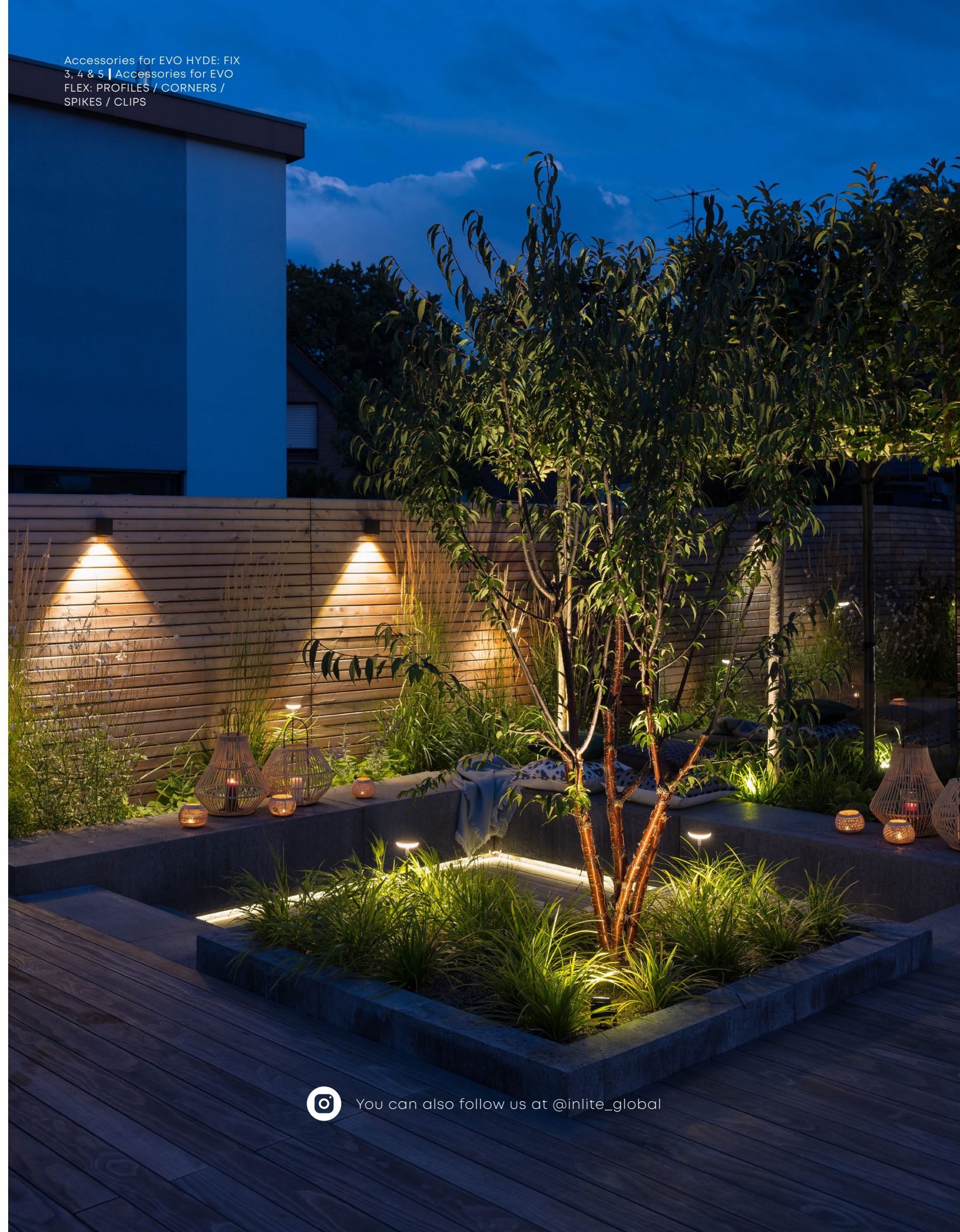

You can also follow us at @inlite_global